

Potain MR 605 B

Data Sheet

FEM 1.001-A3

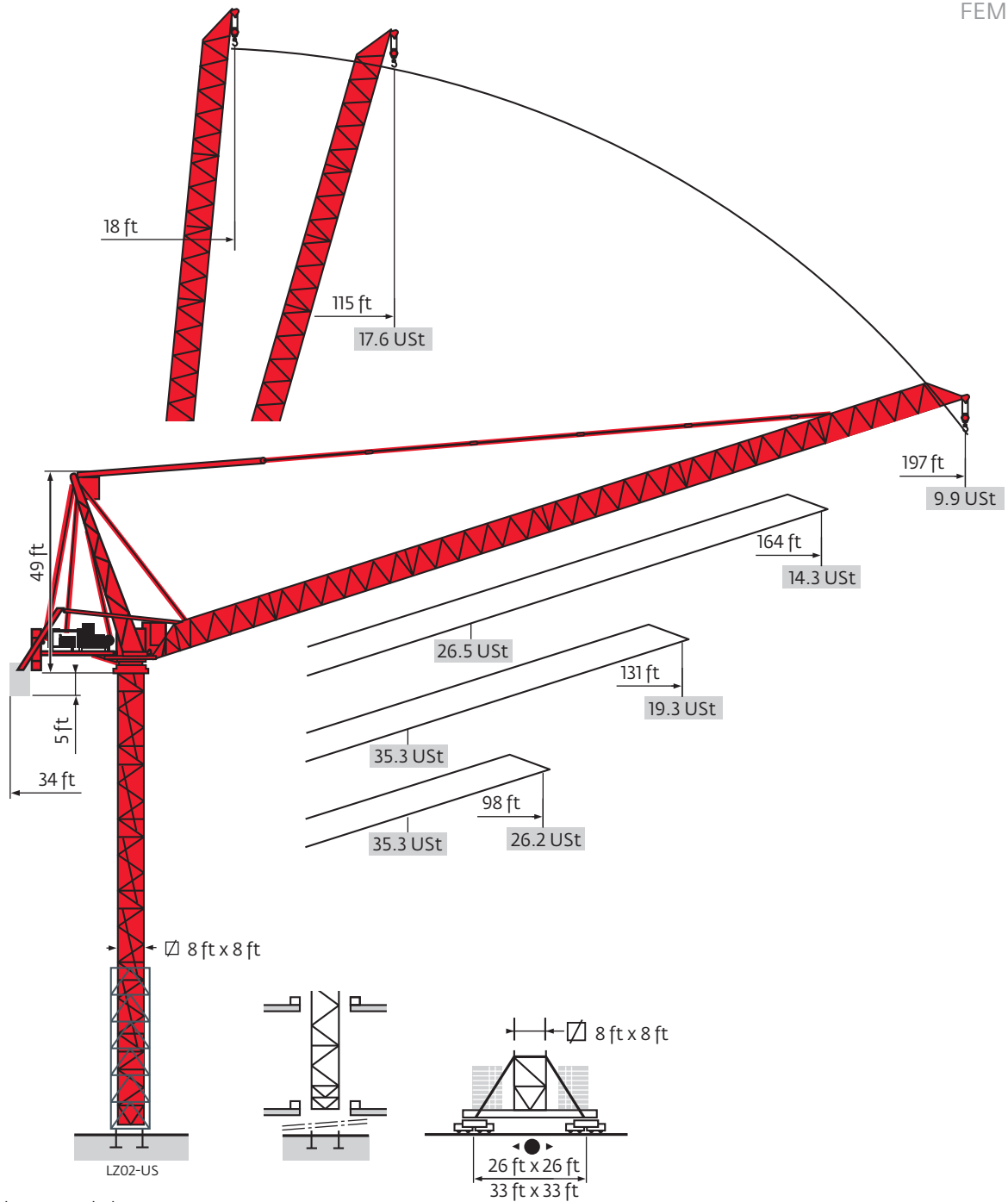

Values have been rounded

Mast

LZ02-US

8 ft

98 ft → 197 ft

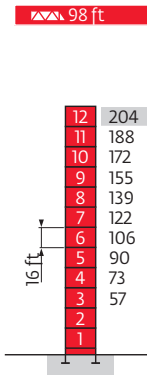

Segment	H (ft)	16 ft	11 ft
131 - 164 ft	194	10	2
164 - 197 ft	199	11	1

P 800 B

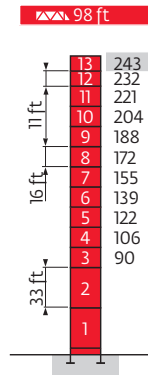

Segment	H (ft)	33ft	16 ft	11 ft
131 - 164 - 197 ft	237	2	10	-

P 850 A

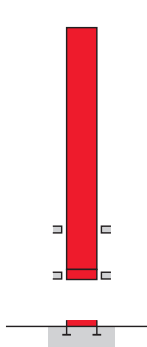

B 800 B

8 ft

98 ft → 197 ft

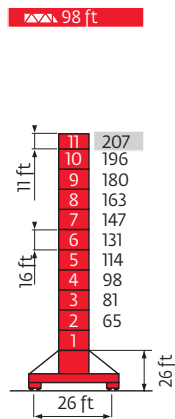

Y 800 A

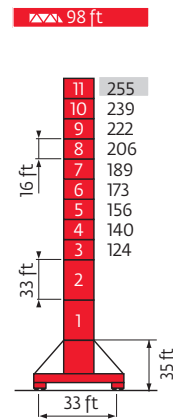

Segment	H (ft)	33ft	16 ft	11 ft
131 - 164 ft	244	2	7	2
164 - 197 ft	250	2	8	1

J 850 A

Load charts

LZ02-US

197 ft	18	▶					115	115	121	131	138	148	154	164	171	180	187	197	ft
▲▲	U						17.6	17.5	16.5	15.3	14.6	13.4	12.9	12	11.6	10.9	10.5	9.9	USt
164 ft	16	▶					93	98	105	115	121	131	135	148	154	164			ft
▲▲	UU						26.5	24.8	23.1	21.1	19.8	18.3	17.6	16.1	15.3	14.3			USt
	U											17.6	16.1	15.3	14.3				USt
131 ft	14	▶					74	82	89	98	105	115	121	131					ft
▲▲	UU						35.3	31.6	29.2	26.1	24.5	22.3	20.9	19.3					USt
	U											17.6							USt
98 ft	11	▶					74	82	89	98									ft
▲▲	UU						35.3	31.7	29.3	26.2									USt
	U										17.6								USt





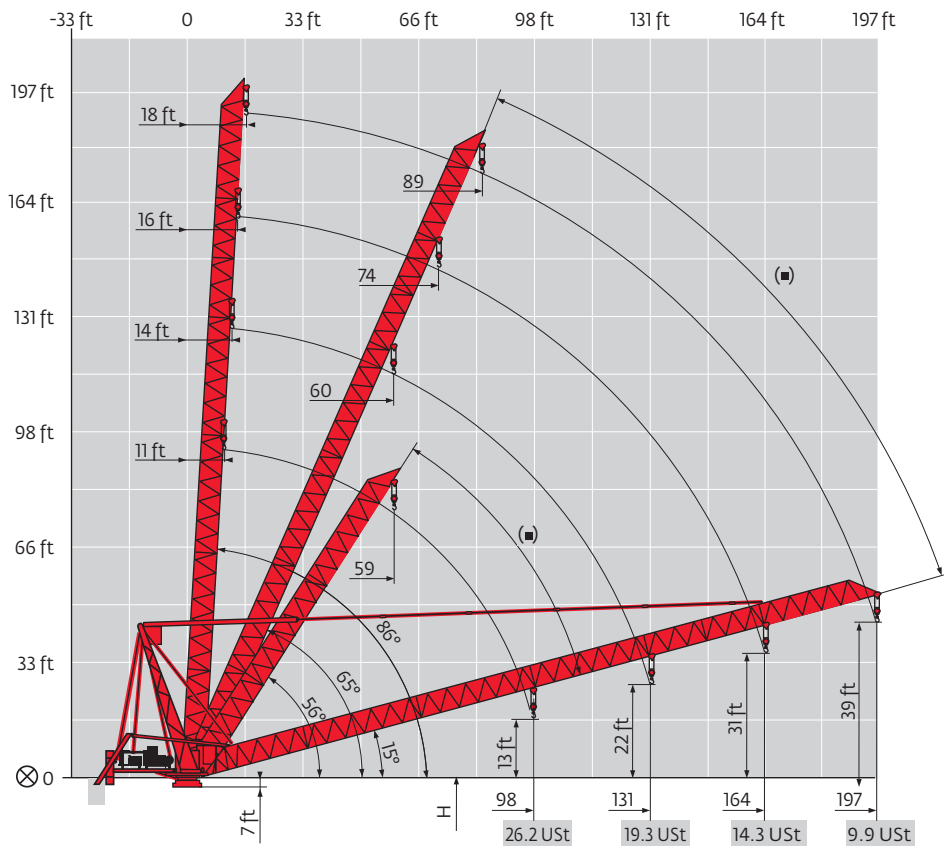



Raised jib





LZ02-US



















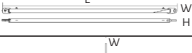







Mechanisms

LZ02-US

MR 605 B H32 60 Hz											hp	kW	
	215 LBR 80 L1090	fpm USt	15/151 17.6	24/236 11.1	37/374 6.5	60/597 3.6	7.5/75 35.3	12/118 22.3	19/187 13	30/299 7.2	215	158	3576 ft
	108 VBR		2 min 44 s								108	79	
	R - 15,8	rpm	0 → 0.8								3 x 7.2	3 x 5.3	
	Y 800 A J 850 A	fpm											
CEI 38 			IEC 38				kVA						
480 V (+6% -10%) 60 Hz			325 kVA										

-  Hoisting
-  Traveling
-  Slewing
-  Traveling
-  Consult us

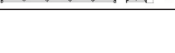
Component weights

Description	L x W x H (ft)	Weight (lb)	Description	L x W x H (ft)	Weight (lb)
Slewing assembly 	14.8 x 16.3 x 11.5	27,778	Towerhead 	46 x 8.8 x 6	19,621
Counter-jib 	21.7 x 10.7 x 7.3	16,512	Hoisting winch 	13.4 x 9.7 x 7	19,841
Ballast lever 	18.5 x 7.4 x 3	6393	Hookblock 	4.7 x 1.7 x 8.9	3549
Moving bar 	30.5 x 1.1 x 1	838	KR840A 	17.2 x 8.1 x 8.3	9204
Counterweight 	3.9 x 1 x 7.4	13,228	KR840C 	11.8 x 8.1 x 8.3	6757
Jib foot 	31.5 x 6.2 x 5.9	5732	KMT850.10C1 	12 x 8.3 x 8.2	9325
Jib section 	34.8 x 6.2 x 5.9	3593	KMT850.10A1 	17.5 x 8.3 x 8.2	12,015
Jib section 	34.1 x 6.2 x 6	5071	KM850.10B1 	33.8 x 8.1 x 8.3	22,200
Jib section 	34.8 x 6.2 x 5.9	3902	K850/KR800B1 	33.6 x 8.3 x 8.2	21,451
Jib section 	34.8 x 6.2 x 5.9	3616	T850A climbing cage rear half 	33.3 x 15.3 x 10.8	20,348
Jib section 	34.8 x 6.2 x 5.9	3086	T850A climbing cage front half 	33 x 15.4 x 8.4	8135
Jib section 	21.1 x 0.8 x 5	4079	Fixing angle P800BUS 	2.5 x 2.5 x 5.9	1477

Notes

Constant improvement and engineering progress make it necessary that we reserve the right to make specification, equipment and price changes without notice. Illustrations shown may include optional equipment and accessories, and may not include all standard equipment.



www.manitowoc.com

Regional Headquarters

Americas

Manitowoc, Wisconsin, USA
Tel: +1 920 684 6621
Fax: +1 920 683 6277

Shady Grove, Pennsylvania, USA
Tel: +1 717 597 8121
Fax: +1 717 597 4062

Europe, Middle East, Africa

Ecully, France
Tel: +33 472 18 2020
Fax: +33 472 18 2000

Asia – Pacific

Shanghai, China
Tel: +86 21 6457 0066
Fax: +86 21 6457 4955

Potain MR 605 B
Code 04-017-.5M-0810